



Gynäkologie, Geburtshilfe
Gynecology, Obstetrics
Gynécologie, Accouchement
Ginecología, Obstetricia



Scheiden spekula
Vaginal specula
Speculums vaginaux
Especulos vaginales



Kristeller

33.4700

70 x 15 mm
Satz, set, jeu, juego

für Kinder
for children
pour enfants
para niños



Spekula
Specula
Spéculum
Especulo

Halter
Retractor
Valve
Valva

Kristeller
kurzes Modell
short model
modèle court
modelo corto

Satz aus je 1 Spekula und 1 Halter
Set of 1 specula and 1 retractor
Jeu de 1 spéculum et 1 valve
Juego de 1 espéculo y 1 valva

Fig.1 33.4701
Fig.2 33.4702
Fig.3 33.4703

Spekula
Specula
Spéculum
Especulo

Fig.1 33.4701-01 70 x 27 mm
Fig.2 33.4702-02 80 x 30 mm
Fig.3 33.4703-03 90 x 36 mm

Halter
Retractor
Valve
Valva

Fig.1 33.4701-11 75 x 23 mm
Fig.2 33.4702-12 85 x 26 mm
Fig.3 33.4703-13 100 x 32 mm

Scheiden spekula
Vaginal specula
Speculums vaginaux
Especulos vaginales



Spekula
Specula
Spéculum
Especulo

Halter
Retractor
Valve
Valva

Kristeller
mit konisch verlaufenden Blättern
with conically shaped blades
avec valvas coniques
con valvas cónicas

Satz aus je 1 Spekula und 1 Halter
Set of 1 specula and 1 retractor
Jeu de 1 spéculum et 1 valve
Juego de 1 espéculo y 1 valva

Fig.1 33.4709
Fig.2 33.4710

Spekula
Specula
Spéculum
Especulo

Fig.1 33.4709-01 105 x 18 mm
Fig.2 33.4710-01 105 x 21 mm

Halter
Retractor
Valve
Valva

Fig.1 33.4709-11 110 x 14 mm
Fig.2 33.4710-11 110 x 17 mm



Spekula
Specula
Spéculum
Especulo

Halter
Retractor
Valve
Valva

Satz aus je 1 Spekula und 1 Halter
Set of 1 specula and 1 retractor
Jeu de 1 spéculum et 1 valve
Juego de 1 espéculo y 1 valva

Fig.1 33.4721
Fig.2 33.4722
Fig.3 33.4723

Spekula
Specula
Spéculum
Especulo

Fig.1 33.4721-01 105 x 26 mm
Fig.2 33.4722-02 105 x 28 mm
Fig.3 33.4723-03 105 x 30 mm

Halter
Retractor
Valve
Valva

Fig.1 33.4721-11 115 x 22 mm
Fig.2 33.4722-12 115 x 24 mm
Fig.3 33.4723-13 115 x 29 mm

Kristeller
langes Modell
long model
modèle longue
modelo largo

Scheiden spekula
Vaginal specula
Speculums vaginaux
Especulos vaginales



Cusco

Fig.1 33.4800 85 x 17 mm
für Jungfrauen
for virgins
pour vierges
para virgenes



Cusco

Fig.1 33.4801 75 x 32 mm
Fig.2 33.4802 85 x 35 mm
Fig.3 33.4803 100 x 35 mm

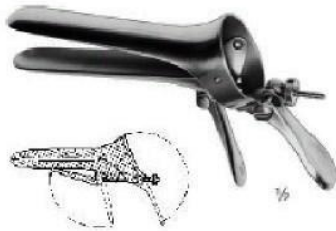

Cusco

Fig.1 33.4805 90 x 23/25 mm
Fig.2 33.4806 100 x 25/27 mm
Fig.3 33.4807 110 x 27/30 mm

Schweizer Modell
Swiss pattern
Modèle suisse
Modelo suizo



Grave

Fig.1 33.4811 85 x 33 mm
Fig.2 33.4812 95 x 33 mm
Fig.3 33.4813 105 x 33 mm

Scheiden spekula
 Vaginal specula
 Speculums vaginaux
 Especulos vaginales



Seyffert
 23,0 cm/9"

- Fig.1 33.4816-01 100 x 17 mm
- Fig.2 33.4816-02 110 x 33 mm



Collin

- Fig.1 33.4821 90 x 29 mm
- Fig.2 33.4822 95 x 32 mm
- Fig.3 33.4823 110 x 40 mm



Pederson

- Fig.1 33.4824 75 x 13 mm
- Fig.2 33.4825 100 x 22 mm
- Fig.3 33.4826 120 x 25 mm

33

Scheiden spekula fur laserchirurgie
 Vaginal specula for laser surgery
 Speculums vaginaux pour chirurgie lasr
 Especulos vaginales para la cirugia laser



mit Absaugung
 with smoke tube
 avec tube d'aspiration
 con tubo de aspiración

Grave

Fig.1	33.4811L	85 x 33 mm
Fig.2	33.4812L	95 x 33 mm
Fig.3	33.4813L	105 x 33 mm



mit Absaugung
 with smoke tube
 avec tube d'aspiration
 con tubo de aspiración

Pederson

Fig.1	33.4824L	75 x 13 mm
Fig.2	33.4825L	100 x 22 mm
Fig.3	33.4826L	120 x 25 mm

Scheiden spekula
 Vaginal specula
 Speculums vaginaux
 Especulos vaginales



Semm

Fig.1	33.4827	95 x 14/18 mm
Fig.2	33.4828	100 x 20/25 mm
Fig.3	33.4829	105 x 27/35 mm

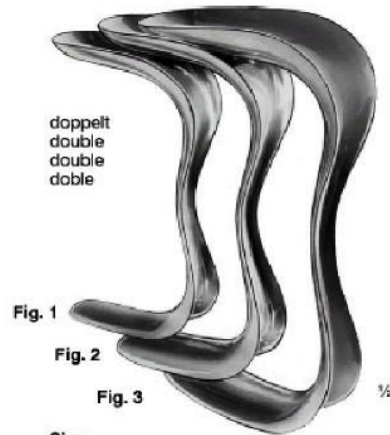

doppelt
 double
 double
 double

Fig. 1

Fig. 2

Fig. 3

Sims

Fig.1	33.4831	25 x 30 mm
Fig.2	33.4832	30 x 35 mm
Fig.3	33.4833	35 x 40 mm



Kallmorgen

Satz aus je 1 Spekula und 1 Halter
 Set of 1 specula and 1 retractor
 Jeu de 1 spéculum et 1 valve
 Juego de 1 espéculo y 1 valva

Fig.1	33.4836-01	17,0 cm
Fig.2	33.4836-02	20,0 cm

33

Spekula
 Specula
 Spéculum
 Espéculo

Fig.1	33.4834-01	70 x 40 mm
Fig.2	33.4834-02	90 x 40 mm

Halter
 Retractor
 Valve
 Valva

Fig.1	33.4835-01	70 x 33 mm
Fig.2	33.4835-02	90 x 33 mm

Scheiden spekula
Vaginal specula
Speculums vaginaux
Especulos vaginales



Brelsky

29,0cm

Fig.1	33.4837-20	100 x 20 mm
Fig.2	33.4837-25	100 x 25 mm
Fig.3	33.4837-30	100 x 30 mm
Fig.4	33.4837-35	100 x 35 mm
Fig.5	33.4837-40	100 x 40 mm

32,0cm

Fig.1	33.4838-20	130 x 20 mm
Fig.2	33.4838-25	130 x 25 mm
Fig.3	33.4838-30	130 x 30 mm
Fig.2	33.4838-35	130 x 35 mm
Fig.3	33.4838-40	130 x 40 mm

35,0 cm/13¾"

33.4839 155 x 30 mm



Doyen

33.4840 70 x 30 mm
24,0 cm/9½"

Scheiden spekula
Vaginal specula
Speculum vaginaux
Especulos vaginales



Mathieu
21,0 cm/8 1/4"

Spekula
Specula
Spéculum
Espéculo
33.4840-01 95 x 17-30 mm

Halter
Retractor
Valve
Valva
33.4840-02 95 x 17-26 mm



Doyen
Fig.1 33.4841 60 x 35 mm
Fig.2 33.4842 90 x 35 mm
Fig.3 33.4843 120 x 35 mm
Fig.4 33.4844 160 x 35 mm

Fig.1 33.4851 60 x 45 mm
Fig.2 33.4852 90 x 45 mm
Fig.3 33.4853 120 x 45 mm
Fig.4 33.4854 160 x 45 mm

Fig.1 33.4861 60 x 60 mm
Fig.2 33.4862 90 x 60 mm
Fig.3 33.4863 120 x 60 mm
Fig.4 33.4864 160 x 60 mm

Lateral vaginal-retractor
 Lateral vaginal retractor
 Speculums lateral
 Especulos laterales



Lateral Retraktor

33.4865
 33.4865L
 2 x 45° gebogen
 2 x 45° curved
 2 x 45° courbe
 2 x 45° curva

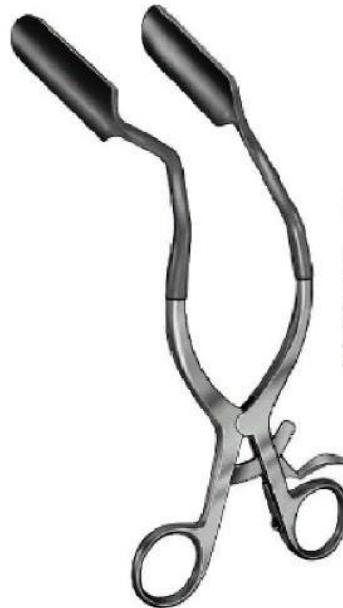

Lateral Retraktor

33.4866
 33.4866L
 2 x 45° gebogen
 2 x 45° curved
 2 x 45° courbe
 2 x 45° curva

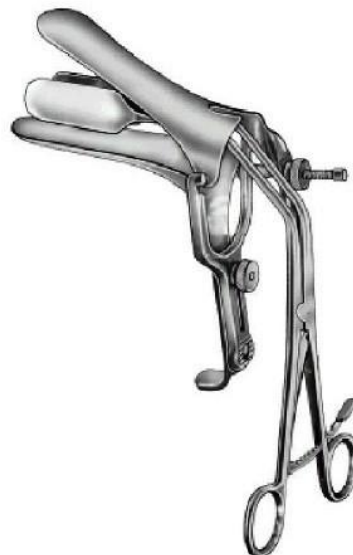

Der Lateral Vaginal-Retractor erweitert Ihr Blickfeld und den Arbeitsbereich.

The Lateral Vaginal Retractor improves access and viewing of the cervix during a procedure.

Le spéculum latéral élargit votre angle visuel et votre sphère du travail.

El espéculo lateral amplia su campo visual y su zona de trabajo.

Scheiden spekula
Vaginal specula
Speculums vaginaux
Especulos vaginales



Auvard

33.4870
mit abnehmbarem Gewicht
with detachable weight
avec poids démontable
con peso desmontable

33.4871
mit festem Gewicht
with fixed weight
avec poids fixe
con peso fijo



Scherbak

33.4873-00
Satz bestehend aus Gewicht
Griff und 5 Blättern
Set consisting of weight
handle and 5 blades
Jeu composé de poids
manche et 5 valves
Juego compuesto de peso
mango y 5 valvas

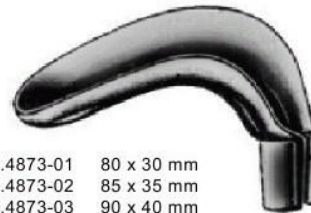

33.4873-01 80 x 30 mm
33.4873-02 85 x 35 mm
33.4873-03 90 x 40 mm

33.4873-10
Griff allein
Handle only
Manche seul
Mango suelto



33.4873-04 55 x 40/60 mm
33.4873-05 70 x 45/70 mm

33

33.4873-40 400g
33.4873-80 800g
Gewicht allein
Weight only
Poids seul
Peso suelto

Endospekula
Endospecula
Endospeculums
Endospeculos

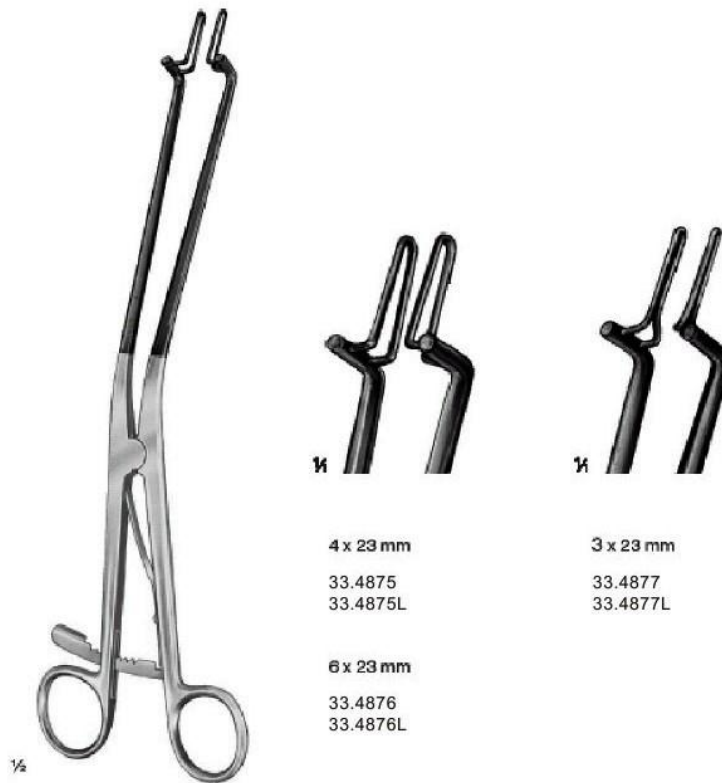

4 x 23 mm
33.4875
33.4875L

3 x 23 mm
33.4877
33.4877L

6 x 23 mm
33.4876
33.4876L

Kogan
28 cm/11"

mit Sperre
with ratchet
avec crémaillère
con cremallera



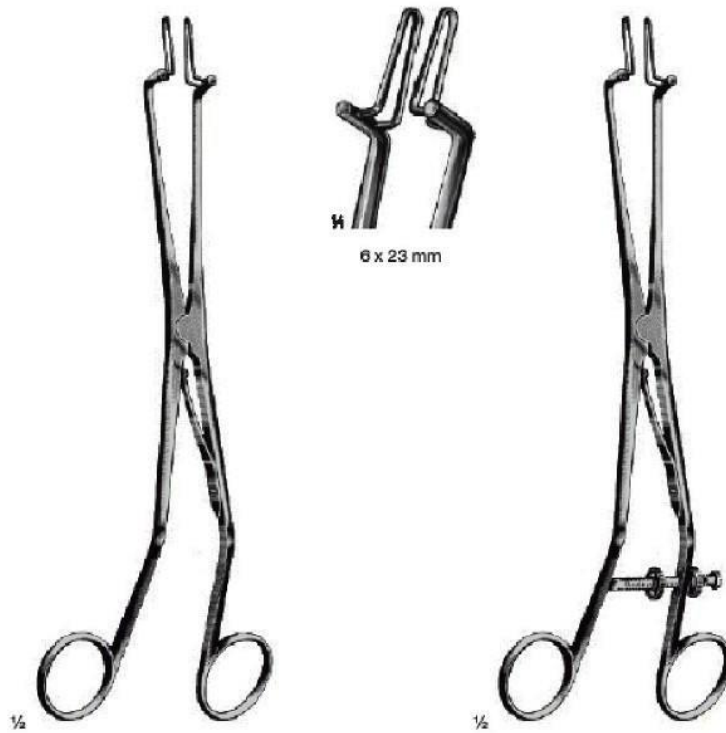

Endospekula
Endospecula
Endospeculums
Endospeculos

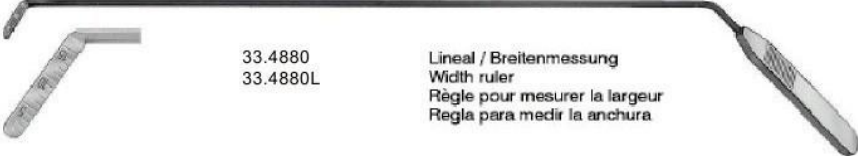
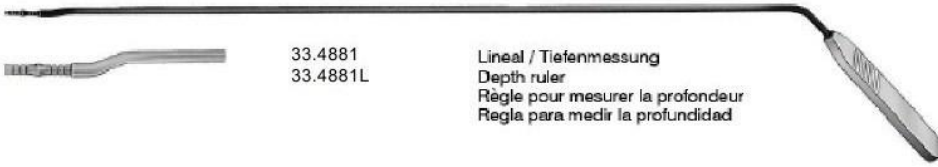

Kogan
33.4878
24 cm/9½"
ohne Sperre
without ratchet
sans crémaillère
sin cremallera

Kogan
33.4879
24 cm/9½"
mit Schraubensperre
with screw ratchet
avec crémaillère de vis
con cremallera de tornillo

Laser-instrumente
 Laser instruments
 Instruments pour la chirurgie laser
 Instrumental para la cirugía laser

	33.4880 33.4880L	Lineal / Breitenmessung Width ruler Règle pour mesurer la largeur Regla para medir la anchura
	33.4881 33.4881L	Lineal / Tiefenmessung Depth ruler Règle pour mesurer la profondeur Regla para medir la profundidad
	33.4884 33.4884L	Emmett Haken Hook Crochet Gancho
	33.4885 33.4885L	Laser Haken Laser hook Crochet à laser Gancho para láser
	33.4886 33.4886L	Iris Haken Iris hook Crochet à iris Gancho para iris
	33.4887 33.4887L	Haken, 2 Krallen Hook, 2 clutches Crochet, 2 griffes Gancho, 2 garras

Uterus dilatatore
 Uterine-dilators
 Dilatateurs uterins
 Dilatadores uterinos

	mm
33.4729-03	3
33.4729-04	4
33.4729-05	5
33.4729-06	6
33.4729-07	7
33.4729-08	8
33.4729-09	9
33.4729-10	10
33.4729-11	11
33.4729-12	12
33.4729-13	13
33.4729-14	14
33.4729-15	15
33.4729-16	16
33.4729-17	17
33.4729-18	18
33.4729-19	19
33.4729-20	20
33.4729-21	21
33.4729-22	22
33.4729-23	23
33.4729-24	24



Hegar
 mit gerieftem Griff und Rinne
 with serrated handle and groove
 avec manche strié et cannelure
 con mango estriado y acanaladura



Hegar
 mit glattem Muidengriff
 with sloped handle
 avec manche aplati
 con mango aplanado

	mm		mm
33.4730	1	33.4760	1,5
33.4731	2	33.4761	2,5
33.4732	3	33.4762	3,5
33.4733	4	33.4763	4,5
33.4734	5	33.4764	5,5
33.4735	6	33.4765	6,5
33.4736	7	33.4766	7,5
33.4737	8	33.4767	8,5
33.4738	9	33.4768	9,5
33.4739	10	33.4769	10,5
33.4740	11	33.4770	11,5
33.4741	12	33.4771	12,5
33.4742	13	33.4772	13,5
33.4743	14	33.4773	14,5
33.4744	15	33.4774	15,5
33.4745	16	33.4775	16,5
33.4746	17	33.4776	17,5
33.4747	18	33.4777	18,5
33.4748	19	33.4778	19,5
33.4749	20	33.4779	20,5
33.4750	21	33.4780	21,5
33.4751	22	33.4781	22,5
33.4752	23	33.4782	23,5
33.4753	24		
33.4754	25		
33.4755	26		
33.4756	27		
33.4757	28		
33.4758	29		
33.4759	30		

Satz		Stück per Satz
Set		Pieces per set
Jeu		Pièces par jeu
Juego	mm	Piezas por juego
33.4901	4-17	14
33.4902	1-26	26

Uterus dilatatore
 Uterine-dilators
 Dilatateurs uterins
 Dilatadores uterinos



Hegar
 mit glattem Muldengriff in Ledertasche
 with sloped handle in leather pouch
 avec manche aplati en pochette de cuir
 con mango aplanado en estuche de cuero

Satz Set Jeu Juego	mm	Stück per Satz Pièces per set Pièces par jeu Piezas por juego
33.4903	4-17	14

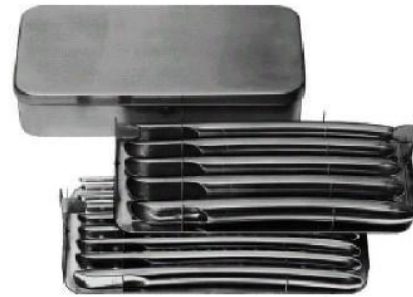

Hegar
 mit glattem Muldengriff in Metalltui
 with sloped handle in metal case
 avec manche aplati en boîte de métal
 con mango aplanado en estuche de metal

Satz Set Jeu Juego	mm	Stück per Satz Pièces per set Pièces par jeu Piezas por juego
33.4904	4-17	14
33.4905	1-26	26

Metalltui allein, für: Metal case only, for: Boîte de métal seule, pour: Estuche de metal suelto, para:	mm	Stück Pièces Pièces Piezas
33.4904-10	4-17	14
33.4905-10	1-26	26

Uterus dilatatore
 Uterine-dilators
 Dilatateurs uterins
 Dilatadores uterinos



Hegar
 doppelt
 double
 double
 doble

	mm
33.4784	1 /2
33.4785	3/4
33.4786	5/6
33.4787	7/8
33.4788	9/10
33.4789	11/12
33.4790	13/14
33.4791	15/16
33.4792	17/18
33.4793	19/20
33.4794	21/22
33.4795	23/24
33.4796	25/26

Satz Set Jeu Juego	mm	Stück per Satz Pieces per set Pièces par jeu Piezas por juego
33.4908	3/4 - 17/18	8
33.4909	1 /2 - 25/26	13



Hegar
 doppelt, double, double, doble
 in Stofftasche, in canvas roll,
 en pochette à toile, en estuche de tela

Satz Set Jeu Juego	mm	Stück per Satz Pieces per set Pièces par jeu Piezas por juego
33.4910	3/4 - 17/18	8



Hegar
 doppelt, double, double, doble
 in Metalletui, in metal case,
 en boîte de métal, en estuche de metal

Satz Set Jeu Juego	mm	Stück per Satz Pieces per set Pièces par jeu Piezas por juego
33.4911	3/4 - 17/18	8
33.4912	1 /2 - 25/26	13

33

Metalletui allein, für: Metal case only, for: Boîte de métal seule, pour: Estuche de metal suelto, para:	mm	Stück Pieces Pièces Piezas
33.4908-10	3/4 - 17/18	8
33.4909-10	1 /2 - 25/26	13

Uterus dilatatore Uterus sonden Uterus-depressoren
 Uterine-dilators Uterine sounds Uterine depressors
 Dilatateurs utérins Hystéromètres Depresseurs utérins
 Dilatadores uterinos Histerometros Depresores uterinos

Uterusdilatatoren
 Uterine-Dilators
 Dilatateurs utérins
 Dilatadores uterinos

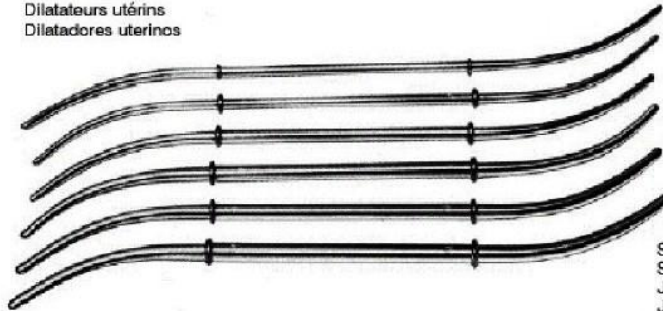

Amerikanische Skala
 American scale
 Echelle américaine
 Escala americana

Hank		mm
Fig. 9/10	33.4913-09	4,5/5
Fig. 11/12	33.4913-11	5,5/6
Fig. 13/14	33.4913-13	6,5/7
Fig. 15/16	33.4913-15	7,5/8
Fig. 17/18	33.4913-17	8,5/9
Fig. 19/20	33.4913-19	9,5/10

Satz		Stück per Satz
Set		Pieces per set
Jeu		Pièces par jeu
Juego	mm	Piezas por juego
33.4913-00	9/10 - 19/20	6

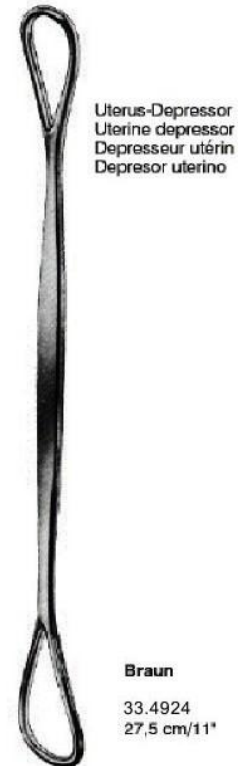
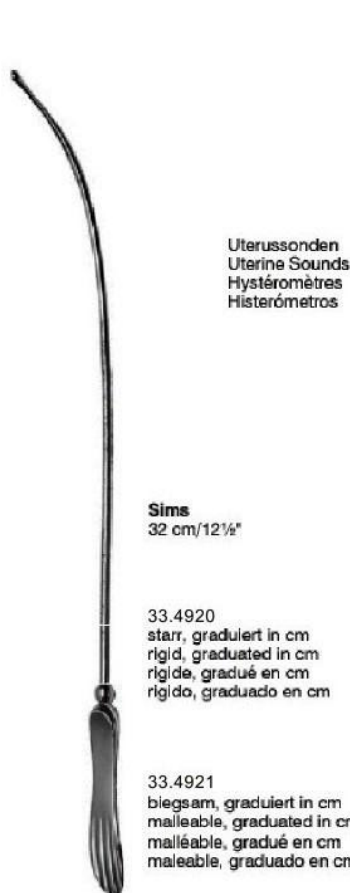

Haken zangen
 Tenaculum forceps
 Pincas a griffes
 Pinzas para coger el cuello del utero

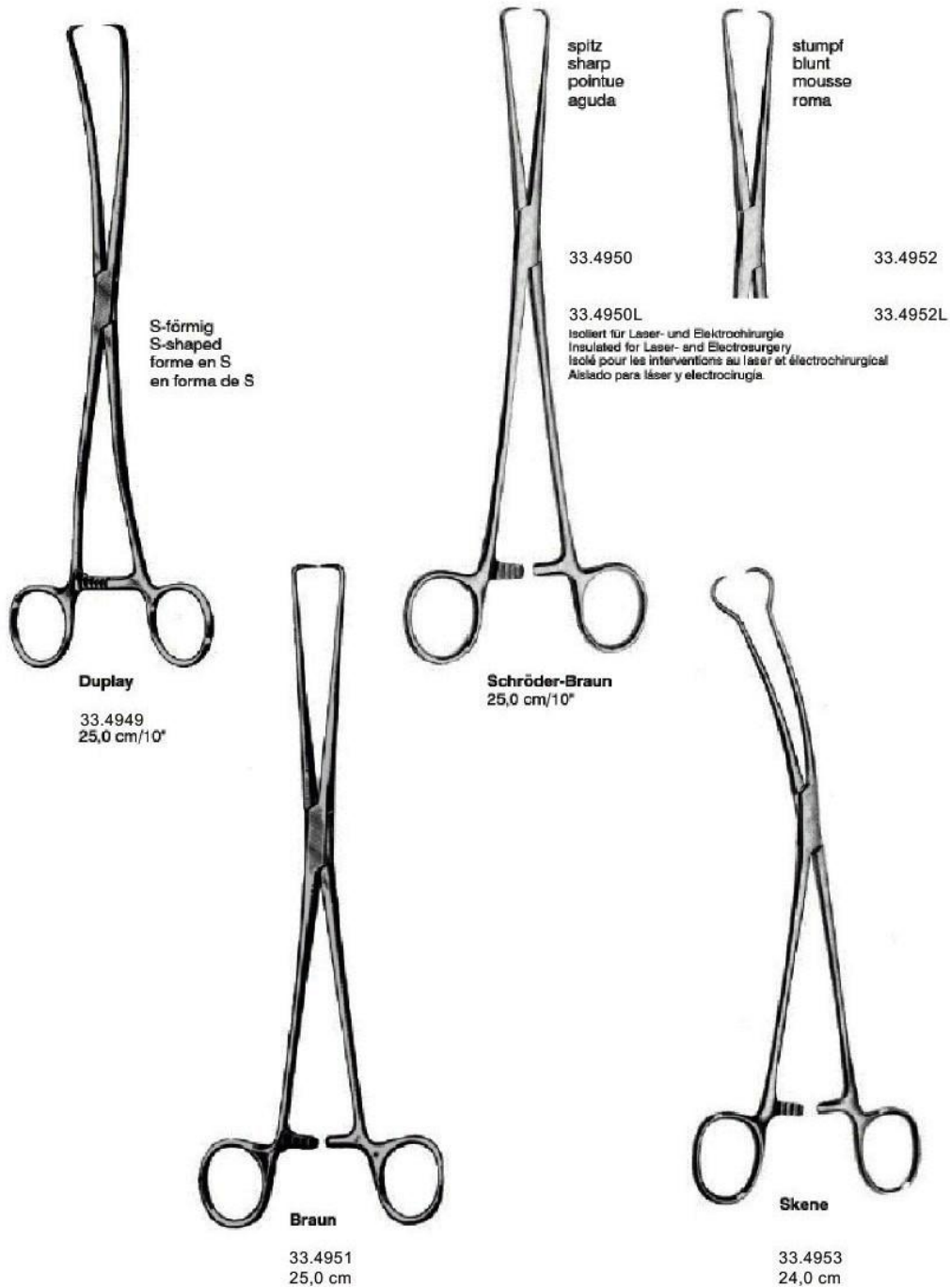

33

Haken zangen
Tenaculum forceps
Pincas a griffes
Pinzas para coger el cuello del utero



Staude-Moore
33.4954
17,0 cm



Czerny
33.4959
20,0 cm

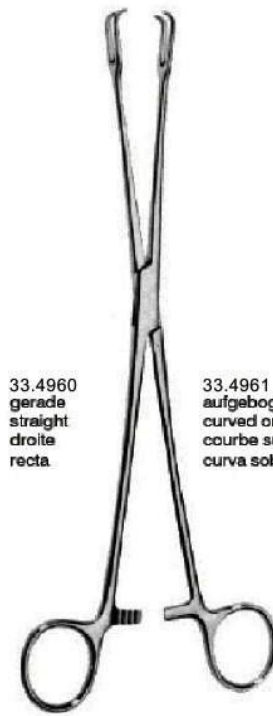

33.4960
gerade
straight
droite
recta.

33.4961
aufgebogen
curved on flat
courbe sur le plat
curva sobre el plano

Schröder
24,0 cm

Haken zangen
 Tenaculum forceps
 Pincas a griffes
 Pinzas para coger el cuello del utero



Teale
 33.4962
 23,0 cm/9"

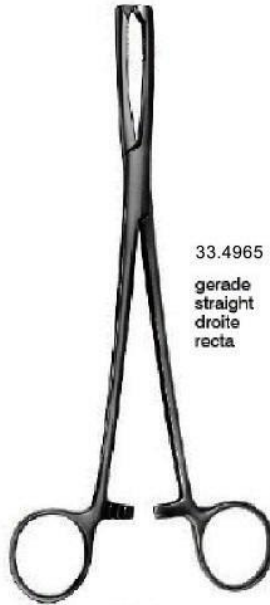

Jakobs
 21,0 cm/8 1/4"

33.4965	33.4966	33.4967
gerade straight droite recta	aufgebogen curved on flat courbe sur le plat curva sobre el plano	seitwärts gebogen curved sideways courbe sur le côté curva lateral

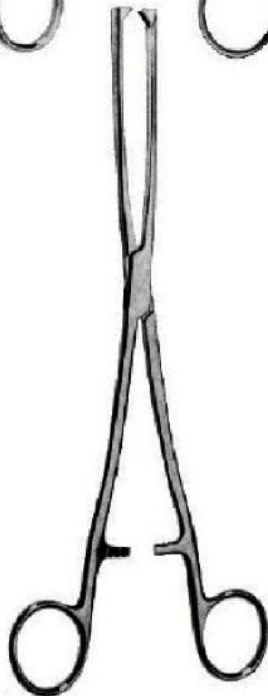

gerade straight droite recta	seitwärts gebogen curved sideways courbe sur le côté curva lateral
33.4970	33.4973
33.4971	33.4974
33.4972	33.4975
Museux 24,0 cm/9 1/2"	

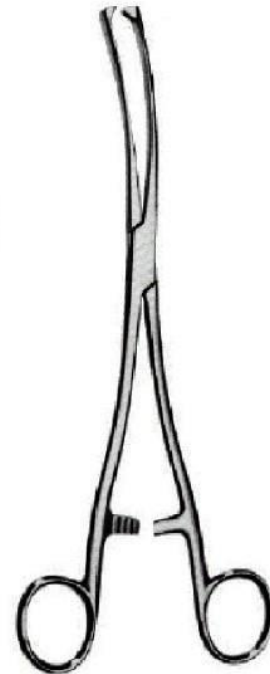

Uterus-polypen zangen Uterus-fabzangen
 Uterine polypus forceps Uterine elevating forceps
 Pincés a polypes utérins Pincés hysterolabes
 Pinzas para polips uterinos Pinzas para el utero

Uterus-Polypenzangen
 Uterine Polypus Forceps
 Pincés à polypes utérins
 Pinzas para polipos uterinos

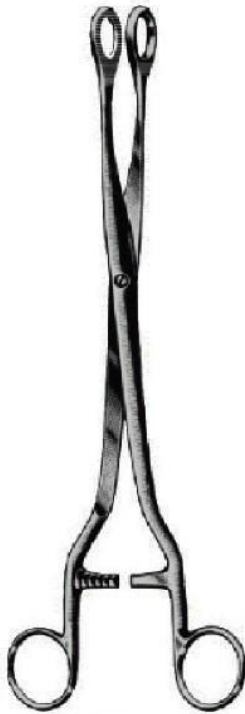

Noto
 33.4989
 27,0 cm/10½"

Uterus-Polypenzangen
 Uterine Polypus Forceps
 Pincés à polypes utérins
 Pinzas para polipos uterinos



Kelly
 33.4990
 32,0 cm/12½"

Ovarien-Fabzange
 Ovarian Elevating Forceps
 Pincés pour les ovaires
 Pinzas para ovarios



Doyen
 33.4995
 20,0 cm

Uterus-fabzangen	Myomheber
Uterine elevating forceps	Myoma screw
Pinces hysterolabes	Tracteur de fibrome
Pinzas para el utero	Tiramiomas

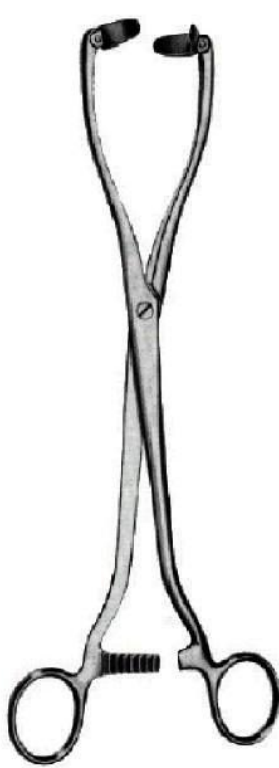

Collin
33.5000
25,0 cm/10"

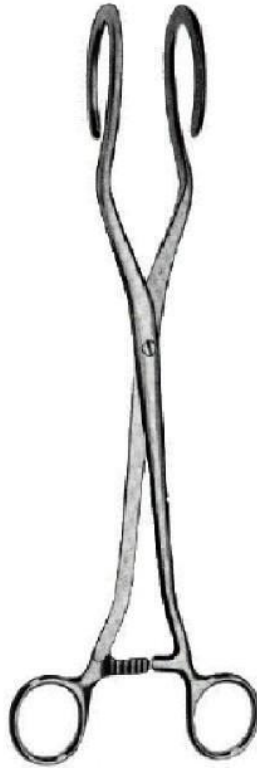

Dartigues
33.5001
27,0 cm/10½"

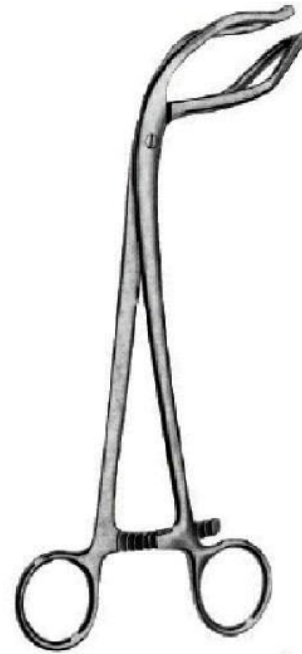

Somer
33.5002
23,0 cm/9"



Doyen
33.5010-01
17,0 cm/6¾"

Myomheber
Myoma Screw
Tracteur de fibrome
Tiramiomas

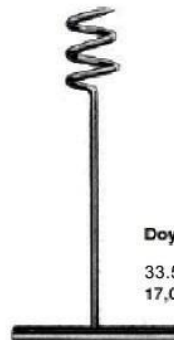

Doyen
33.5010-02
17,0 cm/6¾"

Fabzangen
Grasping forceps
Pinces pour saisir
Pinzas para coger



Maxi-Fabzange
Maxi Grasper
Maxi pince pour saisir
Maxi pinza para coger
33.5015

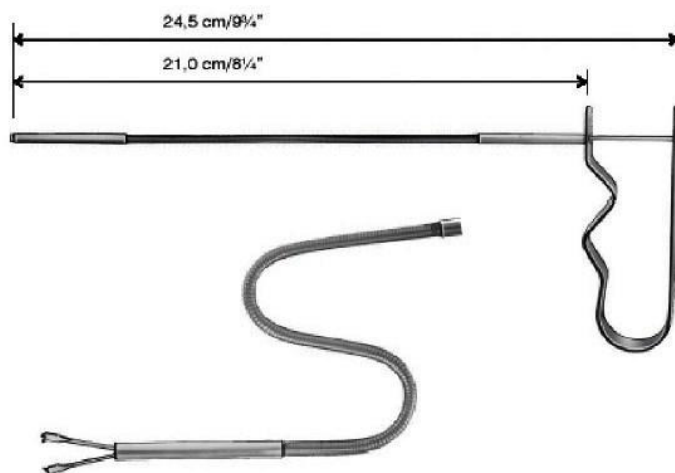

Flexible IUD Fabzange
Serpentine Grasper flexible IUD
Pince flexible IUD
Pinza flexible D.I.U

33.5018

Biopsie zangen
 Biopsy punches
 Pincas emporte-pieces a biopsie
 Pinzas para biopsia

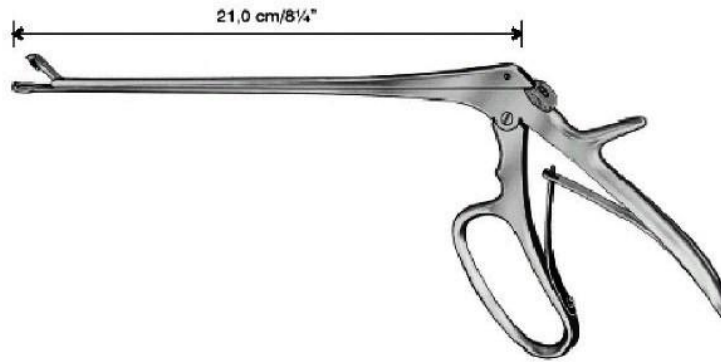

3 x 9 mm

Tischler-Kevorkian
 33.5020



3 x 7 mm

Tischler
 33.5021



2,3 x 4 mm

Baby-Tischler
 33.5022



2,3 x 4 mm

Mini-Tischler
 33.5023



3 x 9 mm

Kevorkian
 33.5024



3 x 7 mm

Coppelson
 33.5025

Biopsie zangen
Biopsy punches
Pinces emporte-pieces a biopsie
Pinzas para biopsia

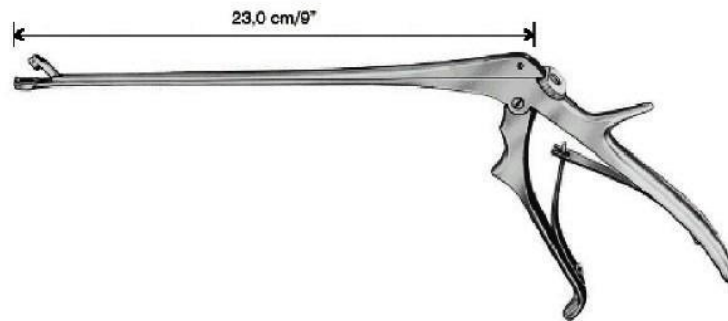

○ 3 x 5 mm

Burke

33.5026



○ 4 x 6,5 mm

Baggish

33.5027
gezahnt
toothed
dentelée
dentada

Biopsie zangen
 Biopsy punches
 Pincas emporte-pieces a biopsie
 Pinzas para biopsia

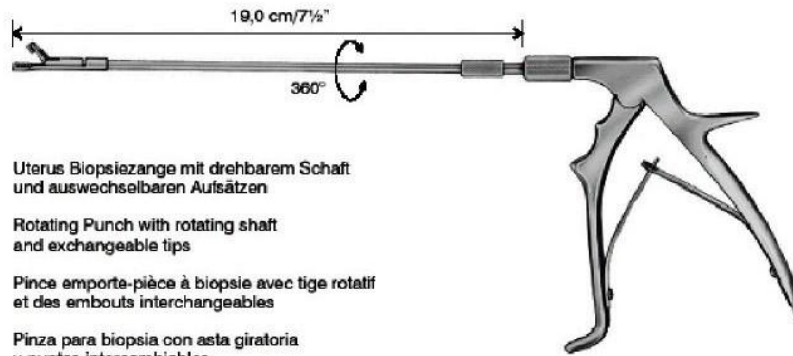

Uterus Biopsiezange mit drehbarem Schaft und auswechselbaren Aufsätzen

Rotating Punch with rotating shaft and exchangeable tips

Pince emporte-pièce à biopsie avec tige rotatif et des embouts interchangeables

Pinza para biopsia con asta giratoria y puntas intercambiables



3 x 7 mm

Uni-Tischler

gerade
straight
droite
recta

33.5028-01
komplett, complete
complet, completo



3 x 7 mm

Uni-Tischler

abwärts gebogen
downwards curved
courbe vers le bas
curva hacia abajo

33.5028-02
komplett, complete
complet, completo



3 x 7 mm

Uni-Tischler

aufwärts gebogen
upwards curved
courbe vers le haut
curva hacia arriba

33.5028-03
komplett, complete
complet, completo



2,3 x 4 mm

Uni-Townsend

gerade
straight
droite
recta

33.5029-01
komplett, complete
complet, completo



2,3 x 4 mm

Uni-Townsend

abwärts gebogen
downwards curved
courbe vers le bas
curva hacia abajo

33.5029-02
komplett, complete
complet, completo



2,3 x 4 mm

Uni-Townsend

aufwärts gebogen
upwards curved
courbe vers le haut
curva hacia arriba

33.5029-03
komplett, complete
complet, completo



3 x 5 mm

Uni-Oval

33.5030
komplett, complete
complet, completo



3 x 9 mm

Uni-Kevorkian

33.5031
komplett, complete
complet, completo



3 x 4 mm

Uni-Burke

33.5032
komplett, complete
complet, completo

33



3,8 x 6 mm

Schuhmacher

33.5032-38
komplett, complete

Biopsie zangen
Biopsy punches
Pincas emporte-pieces a biopsie
Pinzas para biopsia



Uni-Griff mit Ring
Handle with ring
Manche avec anneau
Mango con anillo



Uni-Griff
Handle
Manche
Mango



3 x 7 mm

Uni-Tischler gerade
straight
droite
recta
33.5035-01
Aufsatz allein mit Rohr
Tip only with tube
Embout seul avec tubes-rallonge
Punta sola con tubo de extensión



3 x 7 mm

Uni-Tischler abwärts gebogen
downwards curved
courbe vers le bas
curva hacia abajo
33.5035-02
Aufsatz allein mit Rohr
Tip only with tube
Embout seul avec tubes-rallonge
Punta sola con tubo de extensión



3 x 7 mm

Uni-Tischler aufwärts gebogen
upwards curved
courbe vers le haut
curva hacia arriba
33.5035-03
Aufsatz allein mit Rohr
Tip only with tube
Embout seul avec tubes-rallonge
Punta sola con tubo de extensión



2,3 x 4 mm

Uni-Townsend gerade
straight
droite
recta
33.5036-01
Aufsatz allein mit Rohr
Tip only with tube
Embout seul avec tubes-rallonge
Punta sola con tubo de extensión



2,3 x 4 mm

Uni-Townsend abwärts gebogen
downwards curved
courbe vers le bas
curva hacia abajo
33.5036-02
Aufsatz allein mit Rohr
Tip only with tube
Embout seul avec tubes-rallonge
Punta sola con tubo de extensión



2,3 x 4 mm

Uni-Townsend aufwärts gebogen
upwards curved
courbe vers le haut
curva hacia arriba
33.5036-03
Aufsatz allein mit Rohr
Tip only with tube
Embout seul avec tubes-rallonge
Punta sola con tubo de extensión



3 x 5 mm

Uni-Oval
33.5037
Aufsatz allein mit Rohr
Tip only with tube
Embout seul avec tubes-rallonge
Punta sola con tubo de extensión



3 x 9 mm

Uni-Kevorkian
33.5038
Aufsatz allein mit Rohr
Tip only with tube
Embout seul avec tubes-rallonge
Punta sola con tubo de extensión



3 x 4 mm

Uni-Burke
33.5039
Aufsatz allein mit Rohr
Tip only with tube
Embout seul avec tubes-rallonge
Punta sola con tubo de extensión



3,8 x 8 mm

Schuhmacher
33.5039-38

Aufsatz allein mit Rohr
Tip only with tube
Embout seul avec tubes-rallonge
Punta sola con tubo de extensión

Biopsie zangen
 Biopsy punches
 Pincas emporte-pieces a biopsie
 Pinzas para biopsia

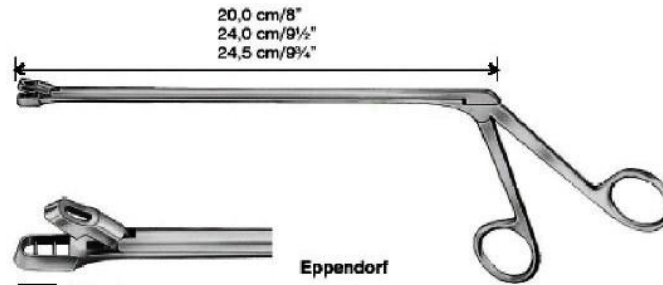

Eppendorf
 33.5040
 20,0 cm/8"



4,5 x 8 mm



Wittner
 33.5041
 20,0 cm/8"
 gebogen, curved
 courbe, curva

Wittner
 33.5042
 20,0 cm/8"
 gerade, straight
 droite, recta

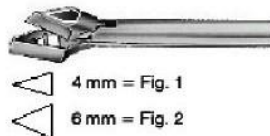

Schumacher
 Fig. 1
 33.5043
 24,0 cm/9 1/2"

Schumacher
 Fig. 2
 33.5044
 24,0 cm/9 1/2"



Kevorkian
 33.5049
 24,5 cm/9 1/2"

Biopsie zangen
 Biopsy punches
 Pincas emporte-pieces a biopsie
 Pinzas para biopsia



Schubert
 33.5051 21,0 cm/8¼"
 33.5052 29,0 cm/11½"

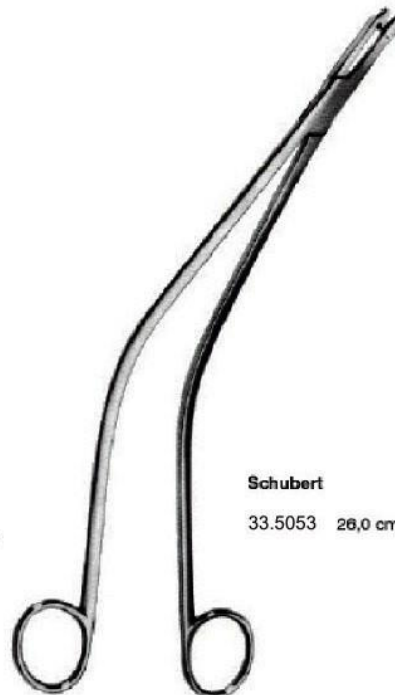

Schubert
 33.5053 26,0 cm/10¼"

Biopsie zangen
Biopsy punches
Pinces emporte-pieces a biopsie
Pinzas para biopsia



Tischler
33.5054
27,0 cm/10½"

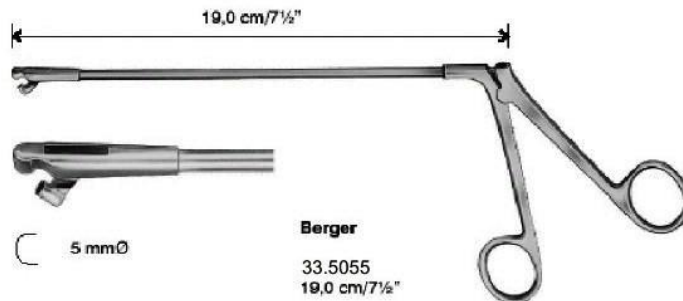

5 mmØ

Berger
33.5055
19,0 cm/7½"

33

Biopsie zangen
Biopsy punches
Pinces emporte-pieces a biopsie
Pinzas para biopsia



Tischler
33.5054
27,0 cm/10½"

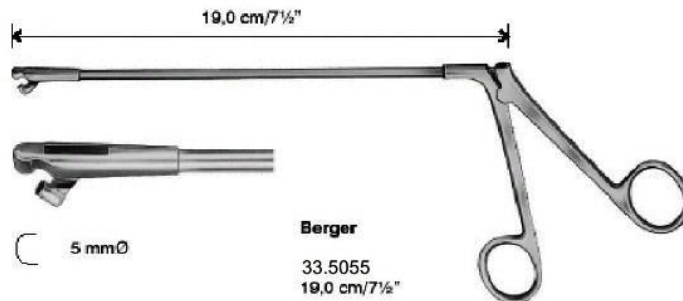

Berger
33.5055
19,0 cm/7½"

33

Biopsie kuretten
 Biopsy curettes
 Curettes pour biopsie
 Curettas para biopsia

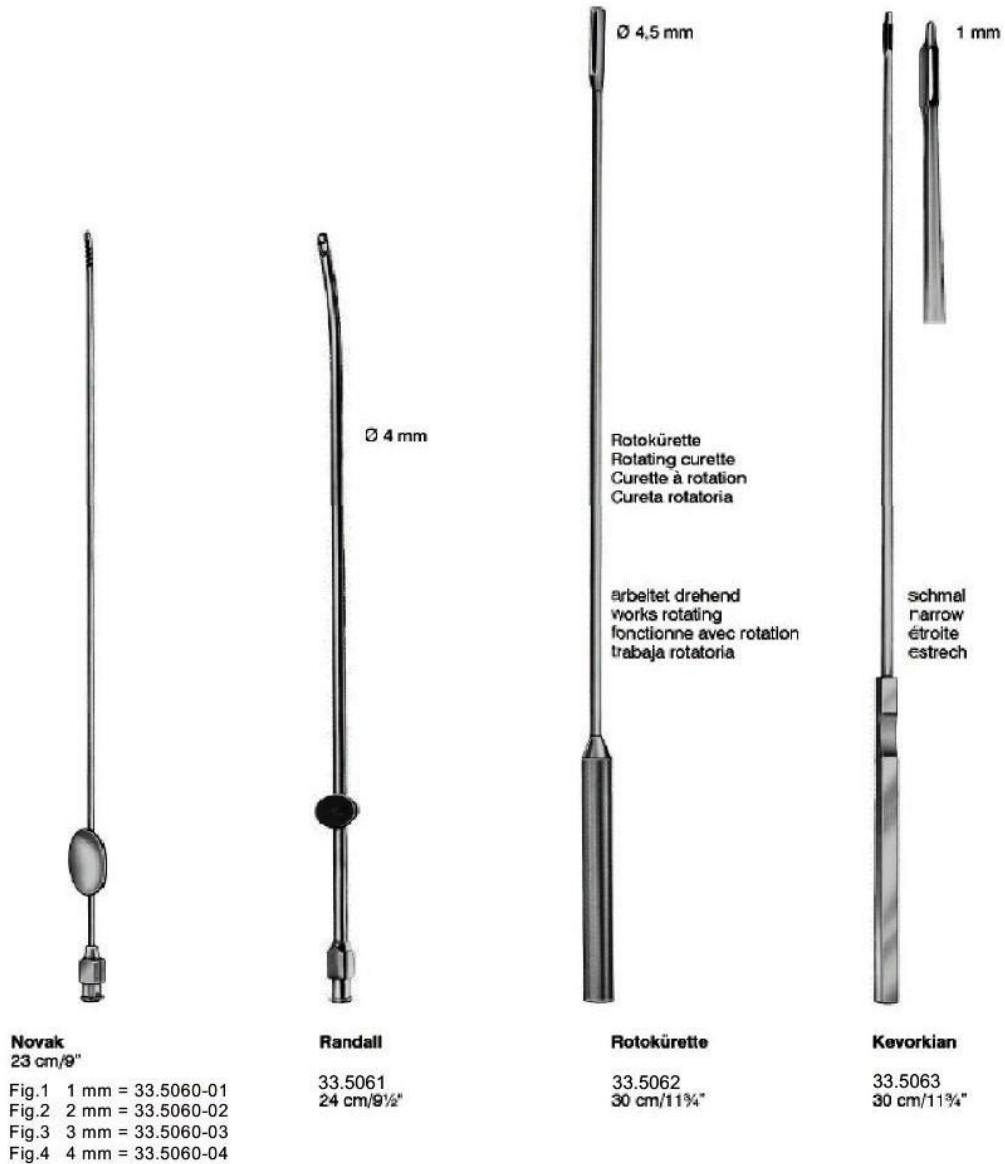

Biopsie kuretten
 Biopsy curettes
 Curettes pour biopsie
 Curettas para biopsia

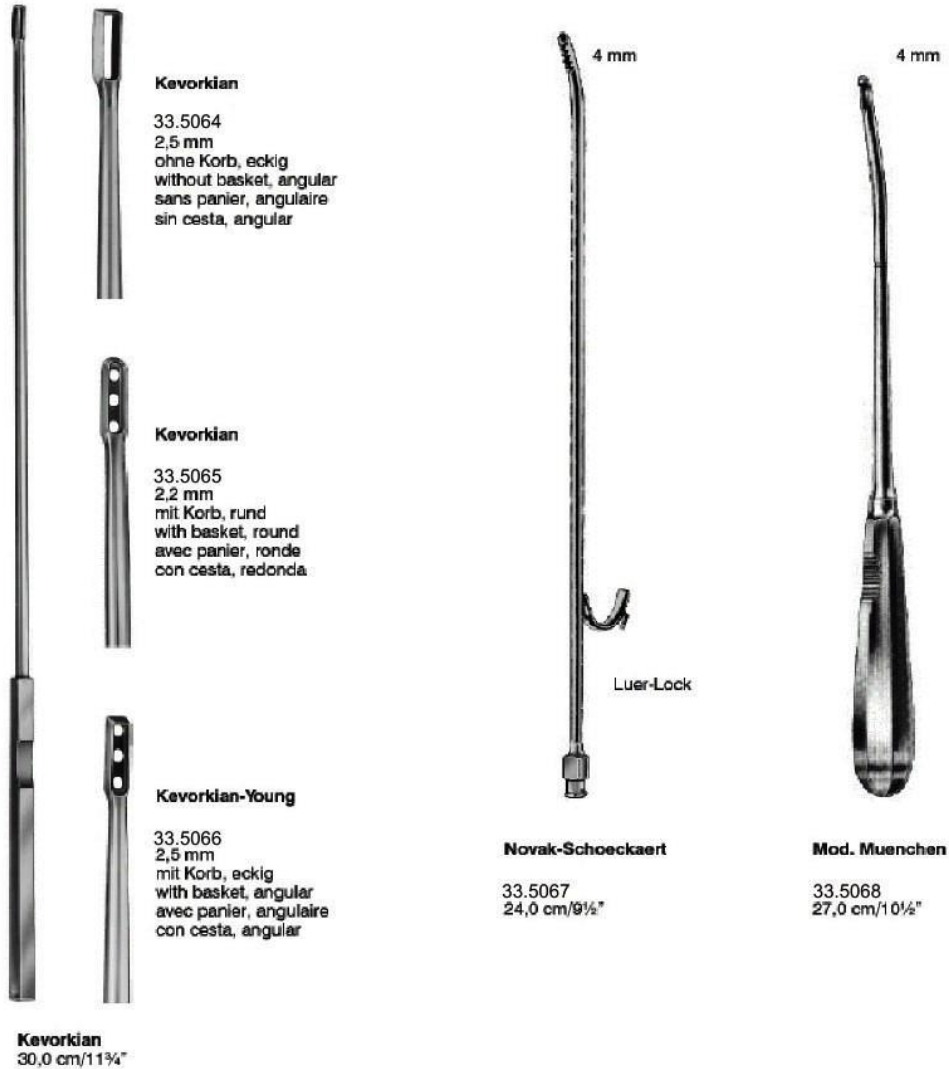

Uterus kuretten
 Uterine curettes
 Curettes uterines
 Curettas uterinas

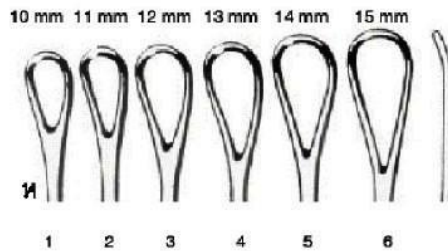

Thomas
 28,0 cm/11"

stumpf, biegsam, glatt
 blunt, malleable, smooth
 mousse, malléable, lisse
 roma, maleable, lisa

- Fig. 1 33.5071
- Fig. 2 33.5072
- Fig. 3 33.5073
- Fig. 4 33.5074
- Fig. 5 33.5075
- Fig. 6 33.5076



Sims
 25,0 cm/10"

	scharf, biegsam sharp, malleable tranchante, malléable cortante, maleable	scharf, fest sharp, rigid tranchante, rigide cortante, rigida	stumpf, biegsam blunt, malleable mousse, malléable roma, maleable	stumpf, fest blunt, rigid mousse, rigide roma, rigida
Fig. 1	33.5081	33.5091	33.5101	33.5111
Fig. 2	33.5082	33.5092	33.5102	33.5112
Fig. 3	33.5083	33.5093	33.5103	33.5113
Fig. 4	33.5084	33.5094	33.5104	33.5114
Fig. 5	33.5085	33.5095	33.5105	33.5115
Fig. 6	33.5086	33.5096	33.5106	33.5116

Uterus kuretten
 Uterine curettes
 Curettes uterines
 Curettas uterinas



Recamier
 31,0 cm/12¼"

	mm	scharf, biegsam sharp, malleable tranchante, malléable cortante, maleable	scharf, fest sharp, rigid tranchante, rigide cortante, rigida	stumpf, biegsam blunt, malleable mousse, malléable roma, maleable	stumpf, fest blunt, rigid mousse, rigide roma, rigida
Fig. 00	5	33.5120-20	33.5130-20	33.5140-20	33.5150-20
Fig. 0	6	33.5120-00	33.5130-00	33.5140-00	33.5150-00
Fig. 1	7	33.5120-01	33.5130-01	33.5140-01	33.5150-01
Fig. 2	8	33.5120-02	33.5130-02	33.5140-02	33.5150-02
Fig. 3	9	33.5120-03	33.5130-03	33.5140-03	33.5150-03
Fig. 4	11	33.5120-04	33.5130-04	33.5140-04	33.5150-04
Fig. 5	12	33.5120-05	33.5130-05	33.5140-05	33.5150-05
Fig. 6	14	33.5120-06	33.5130-06	33.5140-06	33.5150-06
Fig. 7	15	33.5120-07	33.5130-07	33.5140-07	33.5150-07
Fig. 8	16	33.5120-08	33.5130-08	33.5140-08	33.5150-08
Fig. 9	19	33.5120-09	33.5130-09	33.5140-09	33.5150-09
Fig. 10	20	33.5120-10	33.5130-10	33.5140-10	33.5150-10
Fig. 11	21	33.5120-11	33.5130-11	33.5140-11	33.5150-11
Fig. 12	23	33.5120-12	33.5130-12	33.5140-12	33.5150-12
Fig. 13	25	33.5120-13	33.5130-13	33.5140-13	33.5150-13
Fig. 14	30	33.5120-14	33.5130-14	33.5140-14	33.5150-14
Fig. 15	35	33.5120-15	33.5130-15	33.5140-15	33.5150-15
Fig. 16	40	33.5120-16	33.5130-16	33.5140-16	33.5150-16

Uterus kuretten
 Uterine curettes
 Curettes uterines
 Curettas uterinas

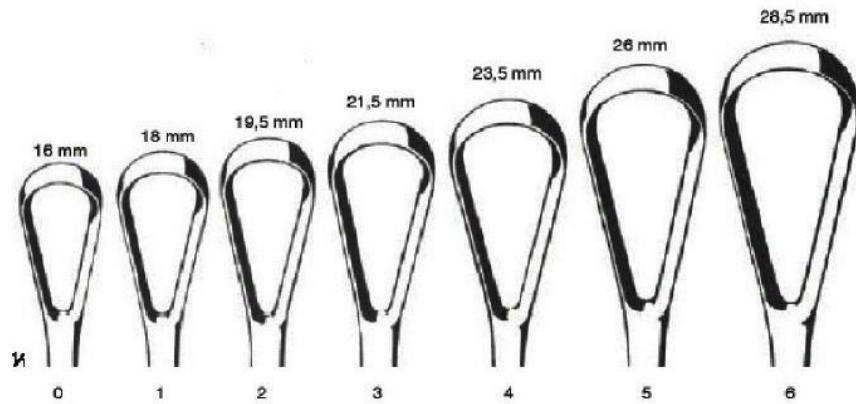

Bumm

	scharf, biegsam sharp, malleable tranchante, malléable cortante, maleable	stumpf, biegsam blunt, malleable mousse, malléable roma, maleable
Fig. 0	33.5160	33.5170
Fig. 1	33.5161	33.5171
Fig. 2	33.5162	33.5172
Fig. 3	33.5163	33.5173
Fig. 4	33.5164	33.5174
Fig. 5	33.5165	33.5175
Fig. 6	33.5166	33.5176

33

Uterus kuretten
 Uterine curettes
 Curettes uterines
 Curettas uterinas

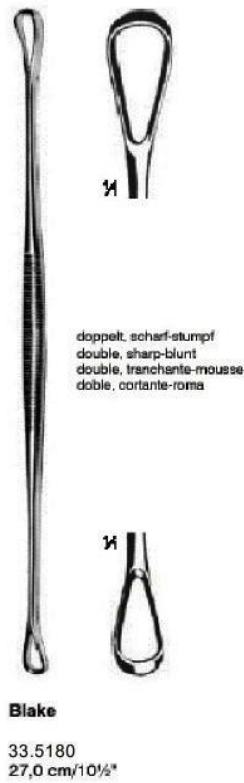

Uterus kuretten
 Uterine curettes
 Curettes uterines
 Curettas uterinas



Beckenzirkel Geburts zangen
 Pelvimeters Obstetrical forceps
 Pelvimetres Pincas obstetriques
 Pelvimetros Pinzas obstetricos



Collin
 33.5301 35,0 cm/13¾"



Martin
 33.5302 34,0 cm/13½"

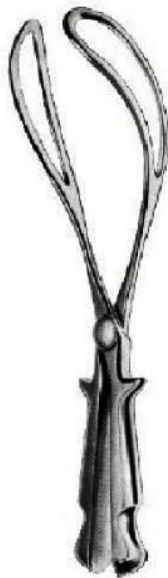

Naegele
 33.5310 36,0 cm/14"
 33.5311 40,0 cm/16"



Simpson-Braun
 33.5318 30,0 cm/12"
 33.5320 33,0 cm/13"
 33.5321 36,0 cm/14"



Simpson-Luikart
 33.5323 36,0 cm/14"

Geburts zangen
Obstetrical forceps
Pinces obstetriques
Pinzas obstetricas



Kielland
33.5325 41,0 cm/16"



Kielland-Luikart
33.5327 40,0 cm/15¾"



Piper
33.5330 44,0 cm/17¼"



Elliot
33.5333 38,0 cm/15"



Mc Lean-Tucker
33.5338 39,0 cm/15½"

33

Pinzenta-und abortus zangen
 Placenta and ovum forceps
 Pincés placentaires
 Pinzas para aborto y placenta

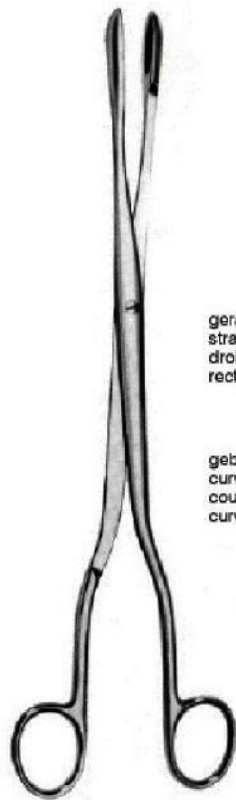

Winter
28,0 cm/11"

gerade
straight
droite
recta

33.5380

33.5381

33.5382

gebogen
curved
courbe
curva

33.5385

33.5386

33.5387

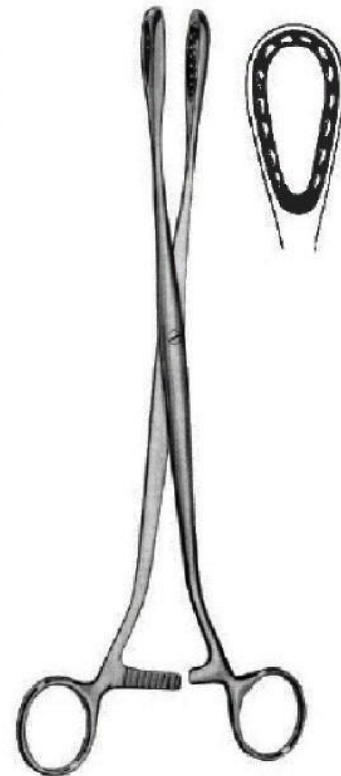
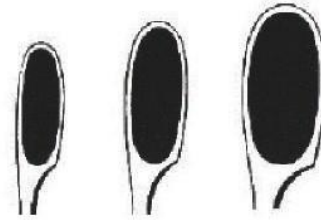

33.5390

Saenger
27,0 cm/10 1/2"

33.5391

gerade
straight
droite
recta

gebogen
curved
courbe
curva

Uterus klemmzange
Uterine hemostasis forceps
Pince-clamp uterine
Pinza-clamp uterina

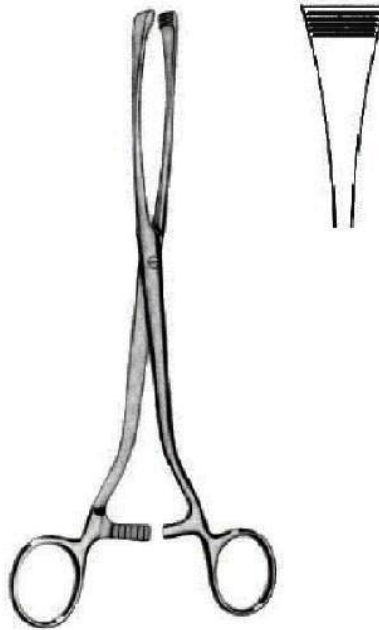

Green-Armytage

33.5395
21,0 cm